

PRE Series 32 Amp Plugs and Sockets

Increased Safety

Zone 1 and 2 - 21 and 22
Gas (G) and Dust (D)

Applications

- Plugs and sockets are used with portable or stationery electrical equipment such as:
 - Lighting systems
 - Conveyors
 - Heaters
 - Motor generators
 - Air conditioning equipment
 - Compressors
 - Pumps
- For use in corrosive atmospheres and installations in Zone 1 and 2 and 21 and 22 of the oil and gas industry, such as:
 - Refineries
 - Chemical and petrochemical plants
 - Pipelines
 - Loading docks
 - Onshore and offshore drilling platforms
 - LNG Trains
 - Gas Compressor Stations

Features

- Plug and socket system is designed with a safe disconnect mechanism to insure maximum hazardous location protection:
 - The contact separation is in a flameproof chamber
 - The automatic electrical disconnection of each phase is contained in a second flameproof chamber
- Short circuit protection is 20 kA, while normal reference is 10 kA.
- Different voltages are color coded for easy identification.
- The sockets are keyed to accept only ATX plugs (other plugs can not be inserted).
- ATX plugs can be used in non-hazardous sockets.

Standard Materials

- Wall Socket: high impact resistance fiberglass reinforced polyester
- Plug, mobile socket and flush socket: polyamide

Certifications and Compliances

◆ ATEX/IECEX Certification

- Certification Type PCX (Plug, socket and mobile socket)**
 - Gas: Zones 1 and 2
 - Conforming to ATEX 94/9/CE: Ⓜ II 2 G
 - Type of Protection: Ex de IIC
 - Temperature class: T6 for $T_a \leq +40$ °C and T5 for $+55$ °C
 - Dust: Zones 21 and 22
 - Conforming to ATEX 94/9/CE: Ⓜ II 2 D
 - Type of Protection: Ex tD A21
 - Surface Temperature: T68 °C
 - Ambient Temperature: -40 °C $\leq T_a \leq +55$ °C
 - Index of Protection according EN/IEC 60529: IP66
 - Impact Resistance (shock): IK10 (Polyester) and IK09 (Polyamide)
 - CE Declaration of Conformity: 50228
 - ATEX Certificate: LCIE 02 ATEX 6068
 - IECEx Certificate: IECEx LCI 04.0014



Technical Data

Breaking Capacity	
AC 1	32 A – 500 V
	11 kW – 220 V
	12 kW – 240 V
AC 22	19 kW – 380 V
	20,7 kW – 415 V
ICC	20 kA

• Certification Type PCX/EN (Flush socket)

- Gas: Zones 1 and 2
 - Conforming to ATEX 94/9/CE: Ⓜ II 2 G
 - Type of Protection: Ex de IIC
 - Temperature class: T6 for $T_a \leq +40$ °C and T5 for $+55$ °C
- Dust: Zones 21 and 22
 - Conforming to ATEX 94/9/CE: Ⓜ II 2 D
 - Type of Protection: Ex tD A21
 - Surface Temperature: T68 °C
- Ambient Temperature: -40 °C $\leq T_a \leq +55$ °C
- Index of Protection according EN/IEC 60529: IP66
- Impact Resistance (shock): IK09 (Polyamide)
- CE Declaration of Conformity: 5C214
- ATEX Certificate: LCIE 02 ATEX 0001U
- IECEx Certificate: IECEx LCI 07.0012U

◆ EURASEC Certification

- Certification Type PCX (Plug, socket and mobile socket)**
 - EURASEC N° TC RU C-FR.Г505.В.00910
- Certification Type PCX/EN (Flush socket)**
 - EURASEC N° TC RU C-FR.Г505.В.00910

◆ Others Certification

- Certification Type PCX (Plug, socket and mobile socket)**
 - Inmetro Certificate: BVC11.0639 ①
- Certification Type PCX/EN (Flush socket)**
 - Inmetro Certificate: BVC11.0598-U ①

PRE Series 32 Amp Plugs and Sockets

Increased Safety

Zone 1 and 2 - 21 and 22
Gas (G) and Dust (D)



Wall Mounting Socket

- Three M25 threaded entries (one on the top and two on the bottom).
- Supplied with one M25 cable gland – Ø 8 to Ø 18.5 mm and two M25 blanking plugs.
- Terminal capacity 2 x 6 mm².
- Fitted with three linked earth terminals.



Plug

- One PG21 integrated cable gland – Ø 8 to Ø 18.5 mm for 3P+N+E versions.
- Terminal capacity 6 mm².



Mobile Socket

- One PG21 integrated cable gland – Ø 8 to Ø 18.5 mm for 2P+E and 3P+E versions.
- One PG29 integrated cable gland – Ø 18 to Ø 25 mm for 3P+N+E versions.
- Terminal capacity 2 x 6 mm².



Flush Socket

- Terminal capacity 2 x 6 mm².

Catalog Numbering Guide – Plugs and Receptacles

PRE
PRE Series
Zone 1, 2, 21 and 22
ATEX / IECEx

3
Pin Configuration:
3 - 2P+E
4 - 3P+E
5 - 3P+N+E

32
Amps:
32 - 32A

R
Equipment:
P - Plug
R - Receptacle
(Wall Mounting)
M - Mobile Socket
F - Flush Socket

P
Voltage:
Y - 100 - 130 Vac 50/60 Hz
B - 200 - 250 Vac 50/60 Hz
R - 380 - 415 Vac 50/60 Hz
N - 480 - 500 Vac 50/60 Hz

LV: Low Voltage

Yellow (Y)	Blue (B)	Red (R)	Black (N)
100/130 Vac	200/250 Vac	380/415 Vac	480/500 Vac

Ⓢ Inmetro certification available on special request only. Contact your local sales for more information



PRE Series 32 Amp Low Voltage Plugs and Sockets

Increased Safety

Zone 1 and 2 - 21 and 22
Gas (G) and Dust (D)

Plugs and Receptacles

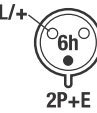
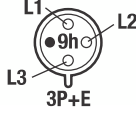
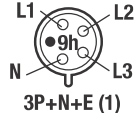
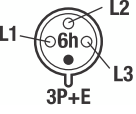
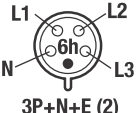
INCREASED SAFETY EX E

Description	Pin Configuration	Weight kg	Volume dm ³	Catalog Number
100/130 Vac 50/60 Hz — Yellow				
Wall Socket		1.9	7.0	PRE332RY
Plug		0.5	4.0	PRE332PY
Mobile Socket		0.8	3.2	PRE332MY
Flush Socket		0.6	2.7	PRE332FY
200/250 Vac 50/60 Hz — Blue				
Wall Socket		1.9	7.0	PRE332RB
Plug		0.5	4.0	PRE332PB
Mobile Socket		0.8	3.2	PRE332MB
Flush Socket		0.6	2.7	PRE332FB
Wall Socket		1.9	7.0	PRE432RB
Plug		0.5	4.0	PRE432PB
Mobile Socket		0.8	3.2	PRE432MB
Flush Socket		0.6	2.7	PRE432FB
Wall Socket		1.9	7.0	PRE532RB
Plug		0.5	4.0	PRE532PB
Mobile Socket		1.0	4.0	PRE532MB
Flush Socket		(1) 120/208 V - 144/250 Vac 50/60 Hz	0.6	2.7
380/415 Vac 50/60 Hz — Red				
Wall Socket		2.0	7.0	PRE432RR
Plug		0.4	4.0	PRE432PR
Mobile Socket		0.8	3.2	PRE432MR
Flush Socket		0.6	2.7	PRE432FR
Wall Socket		2.0	7.0	PRE532RR
Plug		0.5	4.0	PRE532PR
Mobile Socket				
Flush Socket		(2) 200/346 V - 240/415 Vac 50/60 Hz	0.6	2.7
480/500 Vac 50/60 Hz — Black				
Wall Socket		2.0	7.0	PRE432RN
Plug		0.4	4.0	PRE432PN
Mobile Socket		1.0	4.0	PRE432MN
Flush Socket		0.6	2.7	PRE432FN



Shaded catalog numbers are normally stocked items. All other items are made to order.

PRE Series 32 Amp Low Voltage Plug and Socket Accessories and Dimensions

Increased Safety

Zone 1 and 2 - 21 and 22
Gas (G) and Dust (D)

Accessories

	Description	Catalog Number
	M5 earth stud with black neoprene sealing washer and green/yellow earth conductor, length 300 mm Certification type BVE : Exe - IP66 - 03 ATEX 0011 U - IECEx LCI 04.0027U	PREESTM25
	M25 earth continuity adaptor with black neoprene sealing washer and green/yellow earth conductor, length 300 mm Certification type ACC : Exe - IP66 - 03 ATEX 0020 U	PREECAM25

Dimensions

32A – 2P+E – 3P+E – 3P+N+E Versions

Wall Mounting Sockets

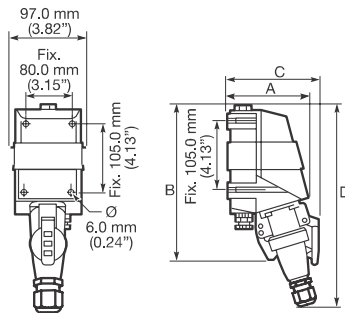

	Dimensions in Millimeters			
	A	B	C	D
2 P + E	140.0	275.0	155.0	370.0
3 P + E	140.0	275.0	155.0	370.0
3 P + N + E	140.0	275.0	165.0	375.0

Plugs

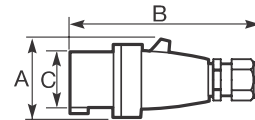

	Dimensions in Millimeters		
	A	B	C
2 P + E	80.0	170.0	67.0
3 P + E	80.0	170.0	67.0
3 P + N + E	80.0	195.0	74.0

Mobile Sockets

Can be mounted on panel - 3.0 mm thickness maximum

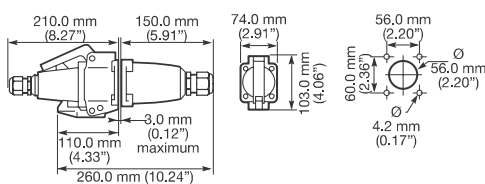

Flush Sockets

