

LN Mercmaster™ ATEX Series Wellglass Luminaires

Zone 2 and 22

Zone 2 and 22
Gas (G) and Dust (D)

Applications

- Enclosed and gasketed fixtures suitable for use in:
 - Marine and wet locations
 - Areas where flammable gases, vapors or combustible dusts are present under conditions defined by the IEC as Zone 2 and 22
 - Applications where energy efficient, high lumen output is required
 - Non-hazardous locations where severe weather conditions, excessive moisture, dirt, dust, corrosive atmosphere or high ambient temperatures are encountered
- Typical applications include:
 - Pulp and paper mills
 - Processing plants
 - Chemical plants
 - Oil refineries
 - Foundries
 - Manufacturing plants
 - Storage areas
 - Waste and sewage treatment
 - Other areas where dust, water, dirt and rough usage are a problem

Features

- Power supply 230/240 V (+6% - 10%) 50 Hz.
- Instant relighting with auxiliary halogen lamps, depending on model (lamps not supplied).
- Fast relighting for 70 W and 150 W high pressure sodium: 5 to 30 seconds depending on the duration of the mains power supply failure.
- Connection via terminal block — 2 x 4 mm² maximum.
- Superior corrosion-resistance: copperfree die-cast mounting hoods, ballast housing and guards have a gray epoxy powder coat, electrostatically applied for complete and uniform protection.
- Wide choice of light sources: high pressure sodium, metal halide, mercury vapor and incandescent.
- Six mounting arrangements to suit any lighting layout – pendant, ceiling, wall bracket, angled or straight stanchion and pendant cone (for dust applications).
- Hinge has high lip for added safety during installation and servicing. Hinge and bolt construction assures 360° compression at all points on ballast housing gasket for positive sealing. Swing away design of captive bolt and nut simplifies servicing.
- All fixtures designed to perform in a -40 °C ambient temperature up to +55 °C.
- Standard dome or 30° angle reflectors made of fiberglass reinforced white polyester. Highly resistant to corrosive atmospheres and vented to improve fixture cooling characteristics.
- Fixture housing mounting hoods and guards are die-cast copperfree aluminum with epoxy powder coat finish.
- All exposed hardware is stainless steel and captive. Stainless thread inserts in the ballast bodies prevent “freezing” of the screws that affix guards and reflectors, simplifying removal for service.
- One piece ballast housing for each component provides even heat dissipation for cooler operation and longer ballast life.
- Fixture bodies are provided with two silicone rubber O-Ring style gaskets that will stay flexible and assure even compression around their circumference. They easily withstand high temperatures, moisture, dirt and dust for worry free operation.



Low Profile Ceiling Mount with Prismatic Globe and Optional Guard



50-200 Watt 25° Stanchion Mount with Prismatic Globe



50-200 Watt 90° Stanchion Mount with Prismatic Globe and Optional Guard



400 Watt Straight Stanchion Mount with Prismatic Glass Globe and Optional Guard

Standard Materials

- Mounting hoods and ballast bodies: die-cast copperfree (4/10 of 1% max.) aluminum
- Hardware and catch assemblies: stainless steel
- Globe: heat and impact resistant internally fluted glass
- Gasket: high temperature silicon
- Reflector: fiberglass reinforced polyester
- Guards: polyester powder coat finished cast copperfree aluminum (LN1 and LN2 sizes) or stainless steel (LN3 and LN4 sizes)

Standard Finishes

- Mounting hoods, ballast bodies and guards: epoxy powder coat finish, electrostatically applied for complete, uniform surface protection
- Reflectors: white polyester finish

LN Mercmaster™ ATEX Series Wellglass Luminaires

Zone 2 and 22

Zone 2 and 22
Gas (G) and Dust (D)

Certifications and Compliances

◆ ATEX/IECEX Certification

• Certification Type: LN

- Gas: Zone 2
 - Conforming to ATEX 94/9/CE: Ⓢ II3 G
 - Type of Protection: Ex nR IIC Gc
- Dust: Zone 22
 - Conforming to ATEX 94/9/CE: Ⓢ II3 D
 - Type of Protection: Ex tc IIC Dc
- Ambient Temperature: +40 °C to +55 °C
- CE Declaration of Conformity: 50217
- ATEX Certificate: LCIE 08 ATEX 6036X
- IECEx Certificate: IECEx LCI 10.0041X
- Index of Protection according EN/IEC 60529: IP66

◆ EURASEC Certification

- EURASEC N° TC RU C-FR.r505.B.00912

Order using catalog numbering guide below or select catalog number from tables on following pages.

Catalog Numbering Guide for LN Series Luminaires

LN Series: LN - LN Series Zone 2 and 22 ATEX/IECEX Certified	1 Body Size: 1 - Size 1 (MLBG) 2 - Size 2 (KPB) 3 - Size 3 (KPBR) 4 - Size 4 (KPB400)	A Mounting: A - Pendant (Rigid Mounting) C - Ceiling D - Pendant Cone F - Pendant (Flexible Mounting) R - Straight Stanchion S - 25° Stanchion W - Wall	H Lamp Type: H - Metal Halide L - High Pressure Sodium M - Mercury Vapor Q - Induction Z - Halogen/ Incandescent	70 Lamp Wattage: 70 - 70 W 80 - 80 W 85 - 85 W Induction only 10 - 100 W 12 - 125 W 15 - 150 W 25 - 250 W 40 - 400 W	A Hub Size: A - M20 2 - 3/4" NPT 3 - 1" NPT 4 - 1-1/4" NPT 5 - 1-1/2" NPT	G2 Globe: G2 - Glass Globe VPGL-2HR G4 - Glass Globe VPGL-4HR	XA Voltage (Magnetic Ballast): XA - 220 Vac, 50 Hz XJ - 230/240 Vac, 50 Hz	P Options: P - PTFE Coating
---	---	---	--	--	--	---	--	--

LN Mercmaster Mercmaster™ ATEX Series Wellglass Luminaires

Zone 2 and 22

Zone 2 and 22
Gas (G) and Dust (D)

T Rating







		Gas			Dust	
		Zone 2 T Rating according Ambient Temperatures			Zone 22 Surface Temperature for Ambient T° = +55 °C	
		+40 °C	+50 °C	+55 °C	Dust Surface	Cable
70 W HPS	T Rating	T4	T4	T4	+113 °C	—
100 W HPS	T Rating	T4	T3	T3	+143 °C	—
100 W Incandescent	T Rating	T4	T3	T3	+143 °C	—
100 W Halogen	T Rating	T4	T3	T3	+143 °C	—
125 W Mercury	T Rating	T4	T3	T3	+143 °C	—
150 W HPS	T Rating	T4	T3	T3	+143 °C	—
150 W Halide	T Rating	T4	T3	T3	+143 °C	—
150 W Incandescent	T Rating	T4	T3	T3	+143 °C	—
150 W Halogen	T Rating	T4	T3	T3	+143 °C	—
250 W HPS	T Rating	T4	T4	T3	+137 °C	—
250 W Halide	T Rating	T4	T3	T3	+143 °C	—
250 W Mercury	T Rating	T4	T3	T3	+143 °C	—
400 W HPS	T Rating	T3	T3	T3	+167 °C	+89 °C
	Cable T°	—	+84 °C	+89 °C		
400 W Halide	T Rating	T3	T3	T3	+171 °C	+87 °C
	Cable T°	—	+82 °C	+87 °C		
400 W Mercury	T Rating	T3	T3	T3	+171 °C	+89 °C
	Cable T°	—	+84 °C	+89 °C		

LN Mercmaster™ ATEX Series Wellglass Luminaires

Zone 2 and 22. High Pressure Sodium

Zone 2 and 22
Gas (G) and Dust (D)







Version : High Pressure Sodium

	Lamp Type	Cable Entry	Lamp Watts	Lampholder	Weight kg	Volume dm ³	Catalog Number
Pendant							
	HPS	1 x 3/4" NPT	70 W	E27	7.4	39	LN1AL702G2XJ
			100 W	E40	9.0	55	LN2AL102G2XJ
			150 W	E40	9.0	55	LN2AL152G2XJ
			250 W	E40	16.0	70	LN3AL252G4XJ
			400 W	E40	19.0	85.2	LN4AL402G4XJ
Pendant Cone							
	HPS	1 x 3/4" NPT	70 W	E27	7.4	39	LN1DL702G2XJ
			100 W	E40	9.0	55	LN2DL102G2XJ
			150 W	E40	9.0	55	LN2DL152G2XJ
			250 W	E40	16.0	70	LN3DL252G4XJ
			400 W	E40	19.0	85.2	LN4DL402G4XJ
Ceiling							
	HPS	5 x 1" NPT with: - 4 x 1" NPT fitted plugs - 2 x 1" NPT-M20 adaptors - 2 x M20 plugs	70 W	E27	7.4	39	LN1CL70AG2XJ
			100 W	E40	9.0	55	LN2CL10AG2XJ
			150 W	E40	9.0	55	LN2CL15AG2XJ
			250 W	E40	16.0	70	LN3CL25AG4XJ
			400 W	E40	19.0	85.2	LN4CL40AG4XJ
Wall							
	HPS	5 x 1" NPT with: - 4 x 1" NPT fitted plugs - 2 x 1" NPT-M20 adaptors - 2 x M20 plugs	70 W	E27	7.4	39	LN1WL70AG2XJ
			100 W	E40	9.0	55	LN2WL10AG2XJ
			150 W	E40	9.0	55	LN2WL15AG2XJ
			250 W	E40	16.0	70	LN3WL25AG4XJ
			400 W	E40	19.0	85.2	LN4WL40AG4XJ
25° Angled Stanchion							
	HPS	1 x 1- 1/4" NPT	70 W	E27	7.4	39	LN1SL704G2XJ
			100 W	E40	9.0	55	LN2SL104G2XJ
			150 W	E40	9.0	55	LN2SL154G2XJ
			250 W	E40	16.0	70	LN3SL254G4XJ
			400 W	E40	19.0	85.2	LN4SL404G4XJ
Straight Stanchion							
	HPS	1 x 1- 1/4" NPT	70 W	E27	7.4	39	LN1RL704G2XJ
			100 W	E40	9.0	55	LN2RL104G2XJ
			150 W	E40	9.0	55	LN2RL154G2XJ
			250 W	E40	16.0	70	LN3RL254G4XJ
			400 W	E40	19.0	85.2	LN4RL404G4XJ

LN Mercmaster™ ATEX Series Wellglass Luminaires

Zone 2 and 22. Incandescent/Halogen

Zone 2 and 22
Gas (G) and Dust (D)







Version : Halogen/Incandescent							
	Lamp Type	Cable Entry	Lamp Watts	Lampholder	Weight kg	Volume dm ³	Catalog Number
Pendant							
	Inc./ Halogen	1 x 3/4" NPT	100 W	E27	7.4	39	LN1AZ102G2
			150 W	E27	7.4	39	LN1AZ152G2
Pendant Cone							
	Inc./ Halogen	1 x 3/4" NPT	100 W	E27	7.4	39	LN1DZ102G2
			150 W	E27	7.4	39	LN1DZ152G2
Ceiling							
	Inc./ Halogen	5 x 1" NPT with: - 4 x 1" NPT fitted plugs - 2 x 1" NPT-M20 adaptors - 2 x M20 plugs	100 W	E27	7.4	39	LN1CZ10AG2
			150 W	E27	7.4	39	LN1CZ15AG2
Wall							
	Inc./ Halogen	5 x 1" NPT with: - 4 x 1" NPT fitted plugs - 2 x 1" NPT-M20 adaptors - 2 x M20 plugs	100 W	E27	7.4	39	LN1WZ10AG2
			150 W	E27	7.4	39	LN1WZ15AG2
25° Angled Stanchion							
	Inc./ Halogen	1 x 1-1/4" NPT	100 W	E27	7.4	39	LN1SZ104G2
			150 W	E27	7.4	39	LN1SZ154G2
Straight Stanchion							
	Inc./ Halogen	1 x 1-1/4" NPT	100 W	E27	7.4	39	LN1RZ104G2
			150 W	E27	7.4	39	LN1RZ154G2

LN Mercmaster™ ATEX Series Wellglass Luminaires

Zone 2 and 22. Mercury Vapor

Zone 2 and 22
Gas (G) and Dust (D)







Version : Mercury Vapor

	Lamp Type	Cable Entry	Lamp Watts	Lampholder	Weight kg	Volume dm ³	Catalog Number
Pendant							
	MV	1 x 3/4" NPT	150 W	E27	7.4	39	LN1AM122G2XJ
			250 W	E40	14.0	70	LN3AM252G4XJ
			400 W	E40	19.0	85.2	LN4AM402G4XJ
Pendant Cone							
	MV	1 x 3/4" NPT	150 W	E27	7.4	39	LN1DM122G2XJ
			250 W	E40	14.0	70	LN3DM252G4XJ
			400 W	E40	19.0	85.2	LN4DM402G4XJ
Ceiling							
	MV	5 x 1" NPT with: - 4 x 1" NPT fitted plugs - 2 x 1" NPT-M20 adaptors - 2 x M20 plugs	150 W	E27	7.4	39	LN1CM12AG2XJ
			250 W	E40	14.0	70	LN3CM25AG4XJ
			400 W	E40	19.0	85.2	LN4CM40AG4XJ
Wall							
	MV	5 x 1" NPT with: - 4 x 1" NPT fitted plugs - 2 x 1" NPT-M20 adaptors - 2 x M20 plugs	150 W	E27	7.4	39	LN1WM12AG2XJ
			250 W	E40	14.0	70	LN3WM25AG4XJ
			400 W	E40	19.0	85.2	LN4WM40AG4XJ
25° Angled Stanchion							
	MV	1 x 1-1/4" NPT	150 W	E27	7.4	39	LN1SM124G2XJ
			250 W	E40	14.0	70	LN3SM254G4XJ
			400 W	E40	19.0	85.2	LN4SM404G4XJ
Straight Stanchion							
	MV	1 x 1-1/4" NPT	150 W	E27	7.4	39	LN1RM124G2XJ
			250 W	E40	14.0	70	LN3RM254G4XJ
			400 W	E40	19.0	85.2	LN4RM404G4XJ

LN Mercmaster™ ATEX Series Wellglass Luminaires

Zone 2 and 22. Metal Halide





Zone 2 and 22
Gas (G) and Dust (D)

Version : Metal Halide							
	Lamp Type	Cable Entry	Lamp Watts	Lampholder	Weight kg	Volume dm ³	Catalog Number
Pendant							
	MH	1 x 3/4" NPT	150 W	E40	9.0	55	LN2AH152G2XJ
			250 W	E40	16.0	70	LN3AH252G4XJ
			400 W	E40	19.0	85.2	LN4AH402G4XJ
Pendant Cone							
	MH	1 x 3/4" NPT	150 W	E40	9.0	55	LN2DH152G2XJ
			250 W	E40	16.0	70	LN3DH252G4XJ
			400 W	E40	19.0	85.2	LN4DH402G4XJ
Ceiling							
	MH	5 x 1" NPT with: - 4 x 1" NPT fitted plugs - 2 x 1" NPT-M20 adaptors - 2 x M20 plugs	150 W	E40	9.0	55	LN2CH15AG2XJ
			250 W	E40	16.0	70	LN3CH25AG4XJ
			400 W	E40	19.0	85.2	LN4CH40AG4XJ
Wall							
	MH	5 x 1" NPT with: - 4 x 1" NPT fitted plugs - 2 x 1" NPT-M20 adaptors - 2 x M20 plugs	150 W	E40	9.0	55	LN2WH15AG2XJ
			250 W	E40	16.0	70	LN3WH25AG4XJ
			400 W	E40	19.0	85.2	LN4WH40AG4XJ
25° Angled Stanchion							
	MH	1 x 1-1/4" NPT	150 W	E40	9.0	55	LN2SH154G2XJ
			250 W	E40	16.0	70	LN3SH254G4XJ
			400 W	E40	19.0	85.2	LN4SH404G4XJ
Straight Stanchion							
	MH	1 x 1-1/4" NPT	150 W	E40	9.0	55	LN2RH154G2XJ
			250 W	E40	16.0	70	LN3RH254G4XJ
			400 W	E40	19.0	85.2	LN4RH404G4XJ

LN Mercmaster™ ATEX Series Wellglass Luminaires

Zone 2 and 22

Zone 2 and 22
Gas (G) and Dust (D)

Item	Description	Catalog Number
White Polyester Reflectors		
For Globe Fixtures – LN1 and LN2 sizes		
	Standard Dome	KR2ST
	30° Angle	KR2AN
For Glass Refractor Fixtures – LN3 and LN4 sizes		
	Standard Dome	CMR4ST
	30° Angle	CMR4AN
Guards		
For Globe Fixtures – LN1 and LN2 sizes		
	Aluminium	KRGU2
		
For Glass Refractor Fixtures – LN3 and LN4 sizes		
	Stainless Steel	KPGU400

LN Mercmaster™ ATEX Series Wellglass Luminaires

Zone 2 and 22

Zone 2 and 22
Gas (G) and Dust (D)

Dimensions in Millimeters (Inches)

Ballast Body with Globe

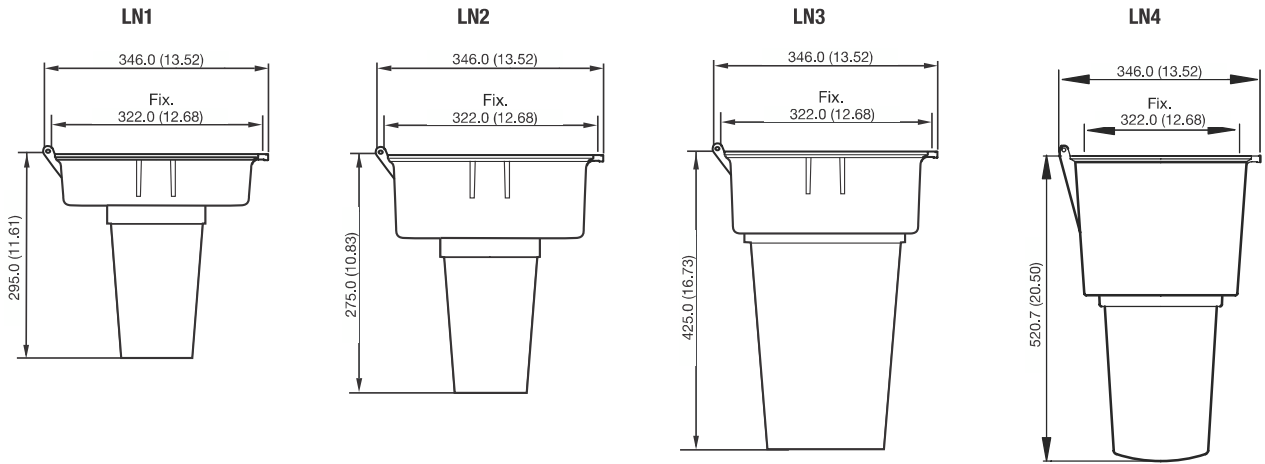

Mounting Hoods

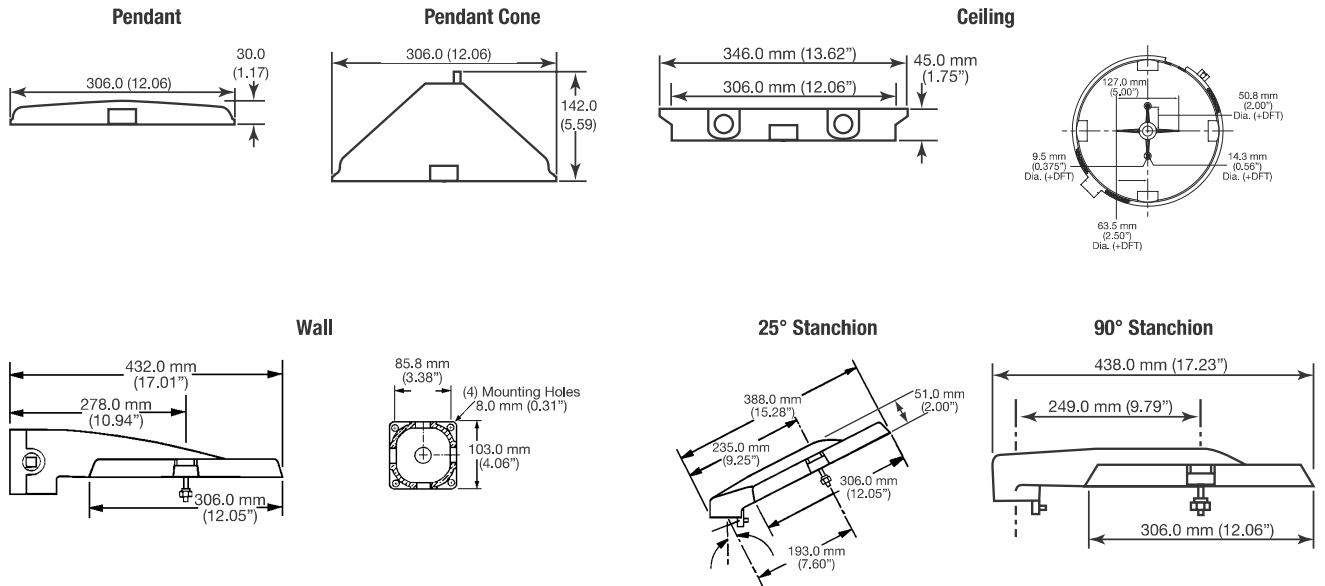

LN Mercmaster™ ATEX Series Wellglass Luminaires

Zone 2 and 22

Zone 2 and 22
Gas (G) and Dust (D)

Photometric Data

Polar curves for a 1000 lm flux, according to NF C 71-120
Luminaire symbol according to NF C 71-121

--- Longitudinal
— Transverse

High Pressure Sodium

70 W HP Sodium — Efficiency 74.6%

150 W HP Sodium — Efficiency 87.3%

250 W HP Sodium — Efficiency 89.1%

400 W HP Sodium — Efficiency 82.3%

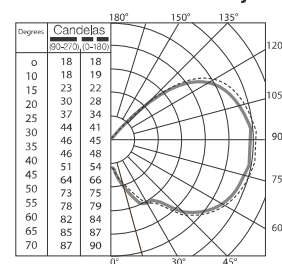
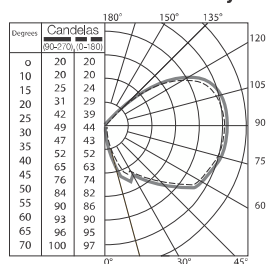
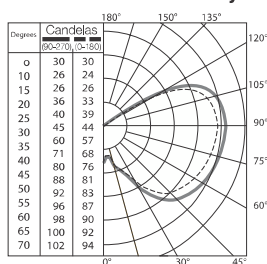
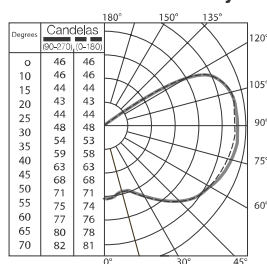

Metal Halide

150 W Metal Halide — Efficiency 82.4%

250 W Metal Halide — Efficiency 96.2%

400 W Metal Halide — Efficiency 89.8%

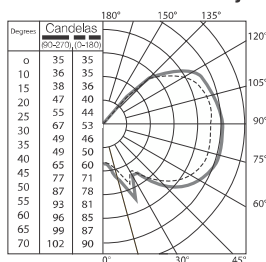
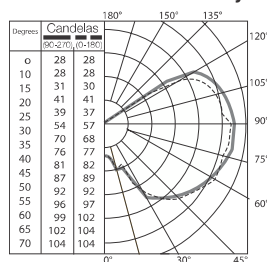
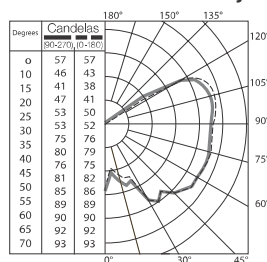

Incandescent or Halogen

150 W HP Incandescent Halogen — Efficiency 90.6%

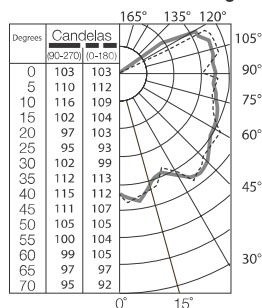

Mercury Vapor

250 W Mercury Vapor — Efficiency 76%

